

FIBC Dischargers

Big-Bag - Entleerstationen

Déchargeuses de Big-Bag

Svuota Big-Bag

SBB



When discharging an FIBC the following problems can be encountered:

- Dust is produced when the bag is opened;
- Difficulties occur when trying to remove substances from the bag which have been compressed during transportation or storage;
- Substances remain trapped in the corners of the bag, making it necessary for the subsequent discharging to be carried out by hand.

In order to avoid such problems we suggest you use our modular FIBC Discharging System.

Our systems can be extended and a range of accessories is available to satisfy every individual requirement with unrivalled efficiency, simplicity and cost.

Standard material: carbon steel.

On request: 304 or 316 stainless steel.

Beim Entleeren von Big-Bags treten oft Probleme auf wie:

- Staubentwicklung beim Öffnen des Big-Bags;
- Big-Bag lässt sich nicht vollständig entleeren, weil sich der Inhalt durch Transport oder längere Lagerung stark verdichtet hat;
- In den Ecken des Big-Bags befinden sich Produktreste, die von Hand entfernt werden müssen.

Bei Big-Bag-Entleerstationen vom Typ SBB werden diese Probleme dank eines Konzepts, welches stark auf individuelle Kundenbedürfnisse ausgerichtet ist, bereits im Vorfeld vermieden.

Die Modulbauweise und eine breite Auswahl an Zubehör bieten effiziente und wirtschaftliche, vor allem aber anwenderfreundliche Lösungen.

Standardausführung aus Stahl.

Auf Wunsch Ausführungen aus Edelstahl 1.4301 oder 1.4401.

Au moment de la vidange des Big-Bags, il se posent généralement les problèmes suivants:

- Dégagement des poussières à l'ouverture du sac;
- Extraction difficile des produits due au tassement généré par le transport ou le stockage;
- Opération manuelle supplémentaire pour vider complètement les sacs du produit restant dans les angles.

Pour éliminer ces inconvénients, nous vous proposons un système de déchargement modulaire et expansible, accompagné de toute une gamme d'accessoires qui permettent de satisfaire aux demandes spécifiques.

Ce système est efficace, simple et économique.

Fabrication de série: en acier au carbone.

Sur demande: en inox AISI 304-316.

Alcuni dei problemi che si manifestano durante le fasi di svuotamento dei Big-Bag sono:

- Emissione di polvere durante l'apertura della bocca;
- Estrazione difficile del prodotto dovuto alla sua compattazione in seguito allo stoccaggio e a trasporto del Big-Bag;
- Svuotamento parziale dei sacconi che contengono prodotti compattati.

Al fine di evitare gli inconvenienti sopra esposti proponiamo un sistema di svuotamento modulare ed espandibile completo di una gamma di accessori che consente di soddisfare richieste specifiche con ineguagliabile efficienza, semplicità ed economicità.

Esecuzione standard: acciaio al carbonio

A richiesta: AISI 304-316

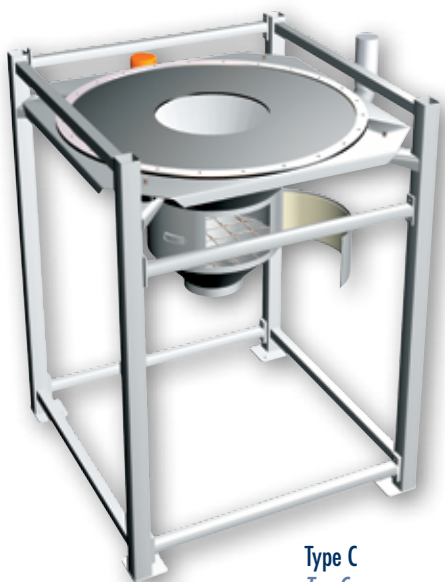
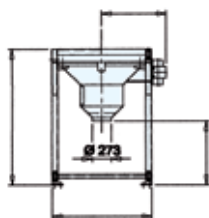
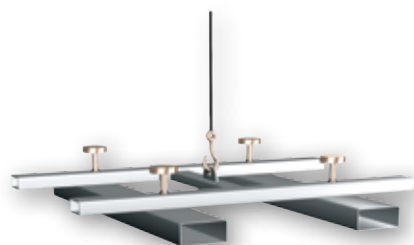

Type C
Typ C
Type C
Tipo C

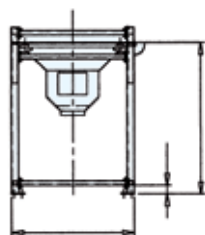

Type S
Typ S
Type S
Tipo S

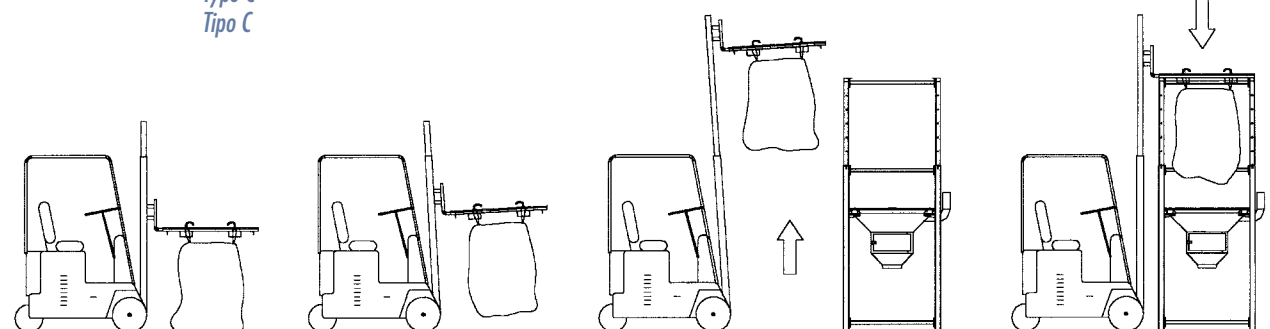
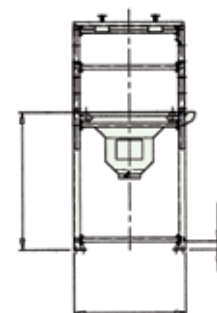
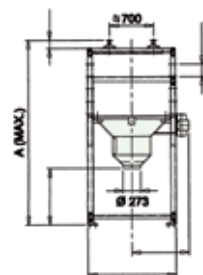

Type	A	B	C	E	F
SBB. 125. C	1.914	1.400	832	100	1.734
SBB. 150. C	2.490	1.800	1.047	160	1.880

Dimensions in mm

Type	A max.	B	C	D	E	F
SBB. 125. S	3.960	1.400	832	130	100	1.734
SBB. 150. S	4.307	1.800	1.047	180	160	1.800

Dimensions in mm

Accessories
Zubehör
Accessoires
Accessori

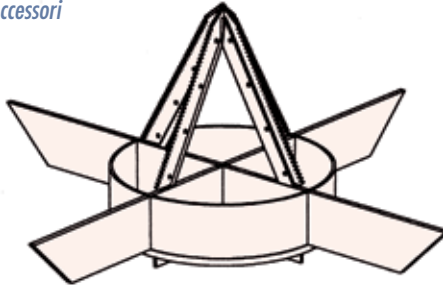

Cutting System
Schnittvorrichtung
Système de coupe
Sistema di taglio



Pneumatic Shaking System
Pneumatische Schüttelvorrichtung
Système pneumatique de secouement
Sistema di scuotimento pneumatico

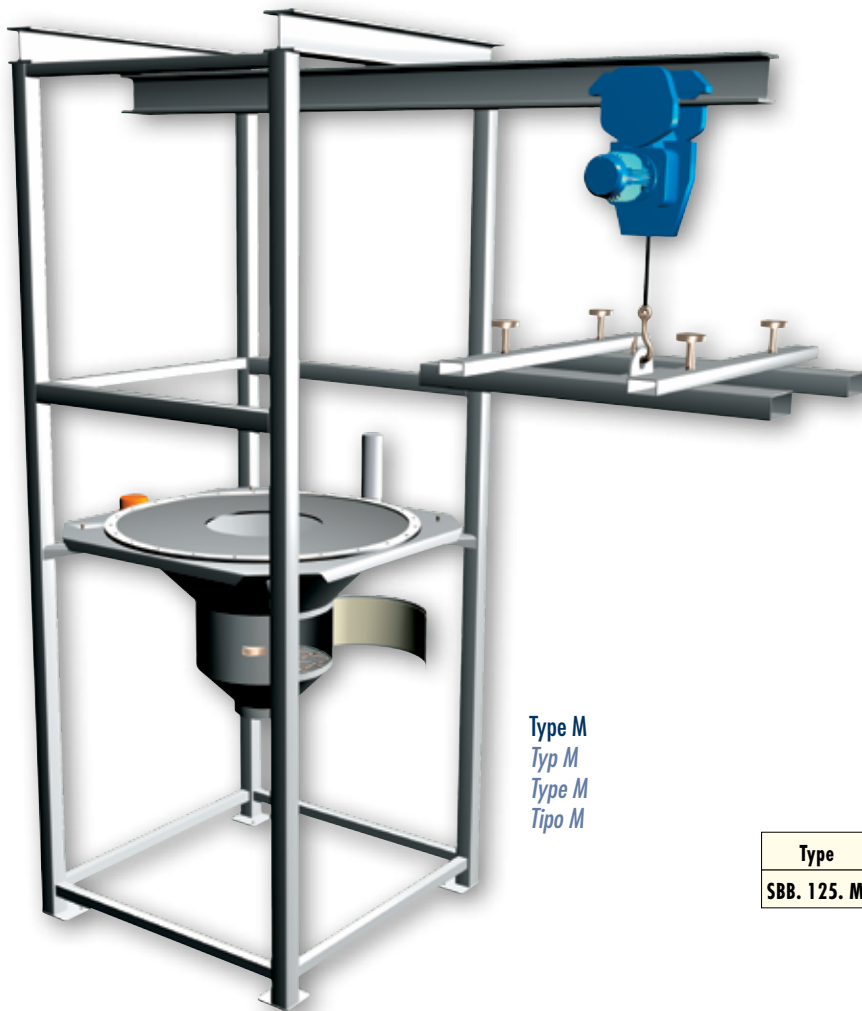

Type M
Typ M
Type M
Tipo M

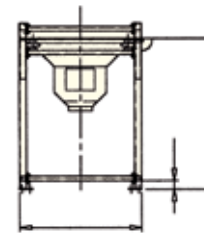
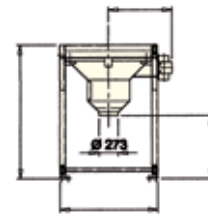

Type	A	B	C	E	F	G	H	L
SBB. 125. M	4.810	1.400	832	160	1.734	2.150	750	3.765

Dimensions in mm



With Rotary Valve
Mit Zellenradschleuse
Avec sas alvéolaire
Con rotavalvola

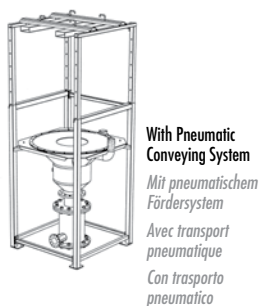

With Pneumatic Conveying System
Mit pneumatischem Fördersystem
Avec transport pneumatique
Con trasporto pneumatico

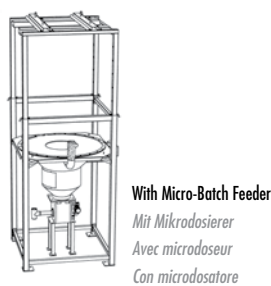

With Micro-Batch Feeder
Mit Mikrodosierer
Avec microdoseur
Con microdosatore

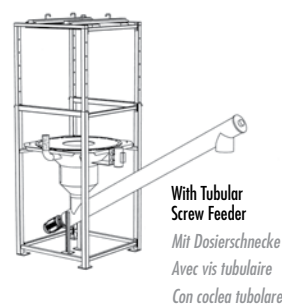

With Tubular Screw Feeder
Mit Dosierschnecke
Avec vis tubulaire
Con coclea tubolare

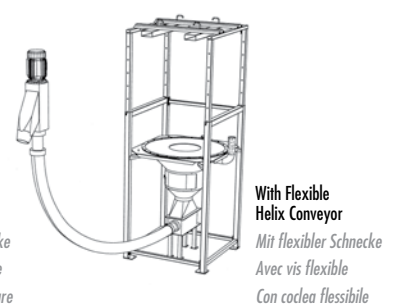

With Flexible Helix Conveyor
Mit flexibler Schnecke
Avec vis flexible
Con coclea flessibile

Further Products - Outra produção - Otros Productos - Altra produzione

